

THE DRAKE LANDING SOLAR COMMUNITY PROJECT – EARLY RESULTS

B. Sibbitt¹, T. Onno², D. McClenahan¹, J. Thornton³, A. Brunger⁴, J. Kokko⁵, and B. Wong⁶

¹CANMET Energy Technology Centre, Natural Resources Canada, Ottawa, Canada

²Gagest Inc., Almonte, Canada

³TESS, Madison, USA

⁴Bodycote Testing Group, Mississauga, Canada ⁵Enermodal Engineering, Kitchener, Canada

⁶SAIC Canada, Ottawa, Canada

ABSTRACT

The Drake Landing Solar Community project connects 52 detached energy-efficient houses with a district heating and seasonal storage system designed to supply more than 90% of the space heating requirements with solar energy. Seven hundred and ninety-eight flat-plate collectors mounted on the roofs of detached garages supply solar thermal energy to charge an underground storage which later supplies heat through a district system to each home in the subdivision. It is the largest residential solar system in Canada and the first of its kind in North America. At the time of writing, the solar system is in a construction and commissioning phase, with one of four solar collector blocks operational and 40 houses occupied. This paper analyzes preliminary data to assess the performance of the first row of solar collectors, determine the heat loss characteristic of the occupied houses and examine how these results compare with expected performance.

INTRODUCTION

In Canada, more than 80% of residential energy consumption is for space and domestic hot water heating, while on average, solar radiation received ranks sixth out of all IEA countries and is higher than in many European nations currently active in the solar energy market. From April to September, Canadian cities receive, on average, over 90% of the incident solar radiation available in Miami, Florida. However, a long-standing barrier to large-scale adoption of solar-heating technology is the relative lack of sunshine during the fall and winter seasons when space heating demand is high.

Provident House and the Aylmer Senior Citizen's Apartment Building were constructed in Ontario roughly 30 years ago with large water tanks for seasonal storage of solar thermal energy for space and service water heating. These systems demonstrated the technical feasibility of solar heating with seasonal heat storage but met limited success for a variety of reasons. Recent advances in solar seasonal storage development

in Europe coupled with cost reduction in solar collectors in Canada led to the evaluation of utilizing the solar resource to displace large fractions of fossil fuel for residential space heating on a community scale in Canada. Promising feasibility study results prompted the design and implementation of the first solar heated community with seasonal storage in North America and the first in the world with a solar fraction over 90%.

The design process involved careful study of the European experience and utilized a single design team with a broad range of expertise including several expert simulators. Since the concept was untried in North America on this scale, the resulting system design was developed with the full knowledge that the system was smaller than the economic optimum.

The overall intent of the Drake Landing Solar Community (DLSC) project is to demonstrate the technical feasibility of achieving substantial conventional fuel energy savings by using solar energy collected during the summer to provide residential space heating during the following winter (seasonal storage). The objective of this paper is to analyze preliminary monitored data to assess the performance of the operating solar collectors and the heat loss characteristic of the occupied houses against the design.

SYSTEM DESIGN

DLSC consists of fifty-two homes located on four streets running east-west, in Okotoks, Alberta. Each home has a detached garage behind the home, facing onto a lane. The garages have been joined by a roofed-in breezeway, creating a continuous roof structure the length of each of the four laneways, to support 2,293 m² of solar collectors.

A borehole thermal energy storage (BTES) field is used to save heat collected in the spring and summer for use the following winter. Installed under a corner of a neighbourhood park, and covered with a layer of insulation beneath the topsoil, 144 boreholes, each 35 m deep, are plumbed in 24 parallel circuits, each a string of 6 series boreholes. Each series string conforms

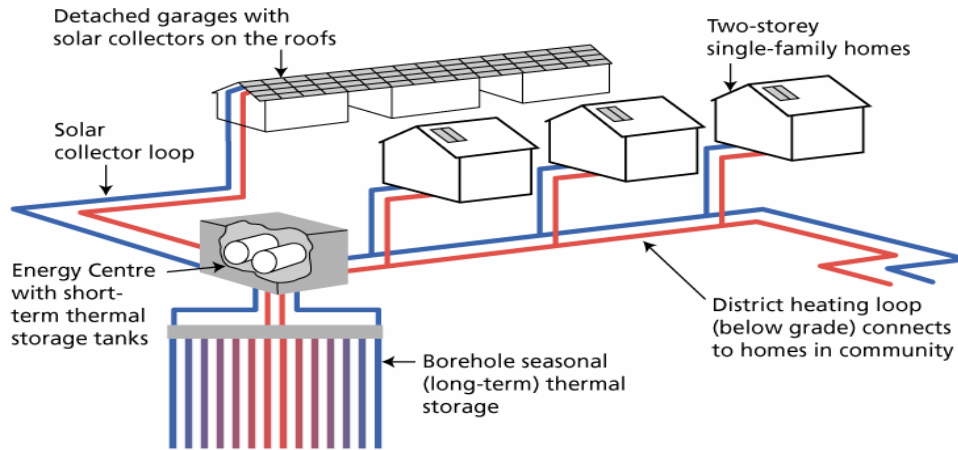

Figure 1. Simplified System Schematic

to a radial flow pattern, with the water flowing from the centre to the outer edge when storing heat, and from the edge towards the centre when recovering heat, so that the highest temperatures will be at or near the centre.

Space heating is supplied to the 52 energy-efficient detached houses through 4 parallel branches of a 2-pipe district heating system. Certified to Natural Resources Canada's R-2000 standard and Alberta's Built Green-Gold level, each house benefits from upgraded insulation, air barrier, windows, low water consumption fixtures and heat recovery ventilation. An integrated air handler and heat recovery ventilator incorporating ECM fans and a large water-to-air heat exchanger supplies forced-air heating and fresh air. An independent, 2-collector, solar domestic hot water system, backed-up with a high-efficiency gas-fired water heater, supplies service hot water.

Most of the district energy system mechanical equipment (pumps, controls, auxiliary gas boilers, etc.) is in a dedicated building (Energy Centre), which also houses two short-term thermal storage (STTS) tanks with a combined water volume of 240 m³. The STTS acts as a buffer between the collector loop, the district loop and the BTES field, accepting and dispensing thermal energy as required. The STTS tanks are critical to the proper operation of the system, because they can accept and dispense heat at a much higher rate than the BTES storage which, in contrast, has a much higher capacity. During periods of intense summer sunshine, the BTES field cannot accept energy as quickly as it can be collected; thus heat is temporarily stored in the STTS tanks, with transfer to the BTES continuing through the night. This situation is reversed in the winter, when heat cannot be extracted from the BTES field quickly enough to meet peak heat demands, typically in the early morning hours. Variable speed drives are employed to power the collector loop and

district heating loop pumps to minimize electrical energy consumption while handling a wide range of thermal power levels. A simplified schematic of the system is shown in Figure 1 and more detailed system descriptions are available (McClenahan et al, 2006 and Wong et al, 2006).

System Operation and Design Challenges

The control system is designed to collect solar energy whenever it is available; initial operation each day heats the collector loop and when the collector loop fluid temperature is hot enough, heat is transferred to the STTS through a plate-frame heat exchanger. When space heating is required, energy from the STTS heats the district loop fluid through a second plate-frame heat exchanger. If there is insufficient energy in the STTS to meet the anticipated heating requirement, heat is transferred from the BTES into the STTS to meet the requirement. If the stored water temperature is insufficient to meet the current heating load, natural gas fired boilers raise the temperature of the district loop as required. When there is more heat in the STTS than is required for space heating in the short term, water is circulated from the STTS through the BTES to store heat for later use.

In summer when space heating requirements are small, virtually all of the solar energy collected is transferred to the BTES. In winter when heating loads tend to exceed collected solar energy, heat is retrieved from the BTES. In the shoulder seasons, heat must be available to the homes and there must also be sufficient capacity available in the STTS to accept large quantities of solar heat. Thermal stratification is important in both the BTES and the STTS to allow the high temperature water to be available for space heating needs while making relatively low temperature water available to supply the collectors.

SYSTEM STATUS

Presently, a number of DLSC subsystems are in a commissioning phase. The first block of 184 collectors is operational. All parts of the energy storage and delivery subsystems are operational and solar energy is being supplied to the district heating system and to the BTES. Since the project has a research component, over 140 data points are recorded by a data acquisition system; most are saved at 10 minute intervals. Due to the dynamic nature of collector operation, many related parameters are recorded at one minute intervals. This system also controls virtually all aspects of the system operation.

The main emphasis of the data analysis at this stage is on quantifying the performance of major subsystems, checking system control sequences, verifying the accuracy and reliability of instrumentation and comparing performance against design expectations.

COLLECTOR PERFORMANCE

Several sample collectors supplied to the DLSC project have been tested at the National Solar Test Facility (NSTF). The performance characteristic, measured at a flow rate of 0.02 l/s, after a 30 day stagnation period is:

$$\eta_{\text{collector}} = 0.693 - 3.835 \left(\frac{T_i - T_a}{G} \right)$$

Performance of the array of 184 collectors was compared to the theoretical output of a single collector. A day was selected (April 12/07) that had close to clear sky conditions and the overall efficiency was analyzed after the morning startup transients. The flow is controlled by a variable-speed pump. Assuming uniform flow distribution in the array, the flow per collector during the day varied from 0.018 l/s down to 0.006 l/s with most time spent at the higher flow rate.

Figure 2 shows the measured and theoretical efficiency and operating conditions for the array (for black and white figure reproductions, the labels for the individual traces are in the same order as the traces, in the middle of the period). Since the ambient temperature and the collector inlet temperature are both fairly high, this data can also be considered similar to summer operation, when the BTES is at an intermediate charge condition.

Midday array operating efficiency is quite high, at 55 to 60%. Measured efficiency is approximately 6.2% higher than the theoretical value. Several possible causes for the difference are identified below.

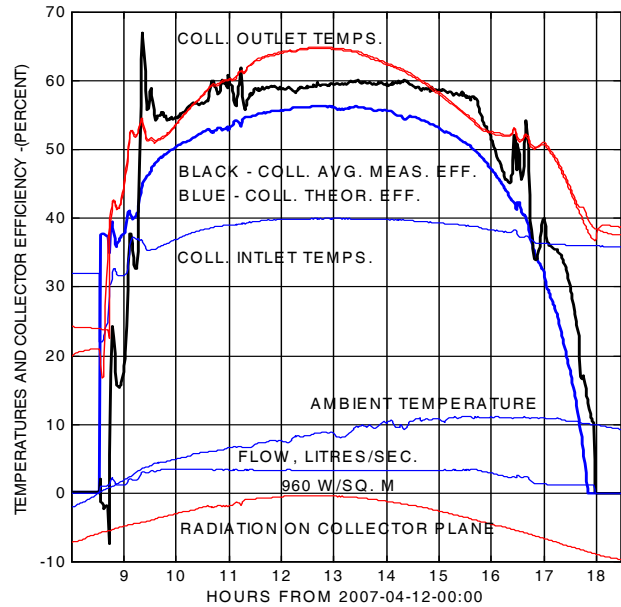

Figure 2. Collector array efficiency 2007-04-12

Figure 3 shows the collector array power measured on both sides of the glycol-to-STTS heat exchanger and the theoretical power. Since two flowmeters operate in series on the glycol circuit, there are two glycol energy traces. The three measured power levels agree within 3.4% at noon.

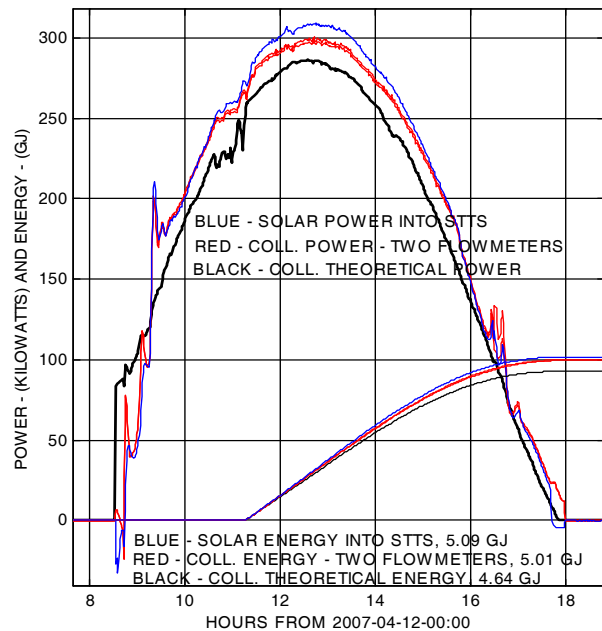

Figure 3. Power and energy comparisons 2007-04-12

The average of the three measured quantities is 4.9% larger than the theoretical value. This result is unexpected since large collector arrays experience heat losses from collector loop piping, which do not occur in a single-collector test. On the other hand, flashed, roof-mounted collectors likely have lower edge and back losses than a single collector, which would tend to improve array efficiency. Since the theoretical power calculation uses the same collector inlet temperature measurement and since three measured quantities are in good agreement, it is also possible that the radiation measurement may be slightly low.

The lower traces in Figure 3 show the integrated energy delivered by the array on the same day. In order to avoid the affect of starting transients and a small amount of cloud cover, the computation was started at 11:14. The average of the three measurements of collected energy is 8.5% more than the calculated theoretical value for the period.

Power and Total Energy on a Clear Day

The peak power (calculated as the average of the three measured quantities) is 301 kW. If the complete array of 798 collectors had been operating in the same environment the peak power would have been 1.31 MW.

Another integration of power was initiated at the start of the day. The measured energy for the whole day was 6.71 GJ, which is 6.7% more than the theoretical value and corresponds to 29.1 GJ for the complete array.

Collector Array Starting Transient

Since the collector circuit is filled with glycol that is exposed overnight to the outdoor ambient and ground temperatures, it must be heated during the start of solar energy collection before energy can be transferred to the STTS. During this period, the glycol-to-water heat exchanger is protected from freezing temperatures by actuating valves that direct the glycol through a bypass which isolates the heat exchanger. The heat transfer fluid recirculates (thereby avoiding the removal of heat from the STTS to heat cold glycol) until it reaches a temperature higher than the top of the storage tank, at which time energy is transferred to the storage.

The startup on April 12, 2007 is shown in Figure 4. The two red traces indicate the outlet temperatures before and after the bypass valve. After the collector pump starts the glycol temperature measured in the energy centre drops below room temperature as the cold glycol recirculates. Eight minutes after the pump starts this

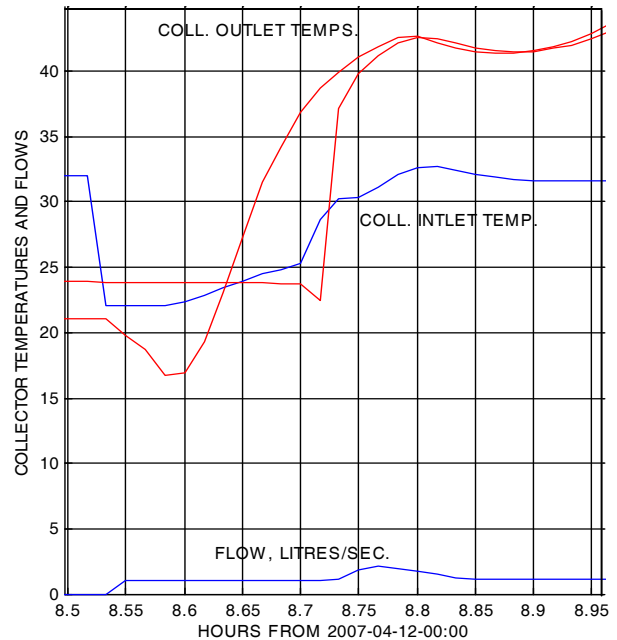

Figure 4. Collector startup inlet & outlet temperatures

temperature rises rapidly and shortly afterwards the flow is directed to the heat exchanger. About five minutes later, the heat exchanger temperature is more than 40 C. A second smaller dip in the collector outlet temperature can be seen about ten minutes later as the initial slug of cold glycol circulates through the energy centre again.

Since the bypass strategy employed allows the early collector operation, when incident radiation is low and glycol temperature is below the STTS temperature, to heat the collector loop, the impact is relatively small. This effect is modeled in the system simulations.

DISTRICT HEATING SYSTEM LOAD

The heating load during the test period is only partially representative of the complete system. The number of heated houses during most of the test period was 40, rather than the ultimate total of 52. Also, a short-circuit bypass link was used to avoid freezing the buried pipe, where houses were not yet connected and the loop was operated at higher than design temperatures. With the subdivision under construction, it is difficult to accurately establish normal heat losses.

The measured energy delivered to the district loop has been examined for an 18 day period to obtain an indication of average power supplied to the houses. An average value of the loss to ground, in the distribution

system, per house, was predicted by the system simulations to be 154 W and has been subtracted from the measured data.

The theoretical house loads were predicted using ESP-r, a sophisticated simulation program which allows the house loss to be analyzed on a room-by-room basis. In order to extract the heat loss characteristic from highly dynamic hourly loads, the outdoor temperature and power consumption were sorted into temperature bins of one degree width. Averages were then generated for each bin to allow plotting of data points with equal statistical weight.

Figure 5 shows that the outdoor temperature, at which no heating is required, is higher than predicted. The difference may be due to the short circuit links outside houses that are not yet connected and to higher than design district loop temperatures, used before the subdivision was complete. The slope of the measured heat load curve also appears to be somewhat higher than simulated. Normally the houses are heated by temporary propane units until just before homeowners move in. However the permanent space heating units may have been used for some period while workers were still in the building, with windows open, etc. It will only be possible to accurately establish the heat loss when the houses are fully occupied during the next heating season.

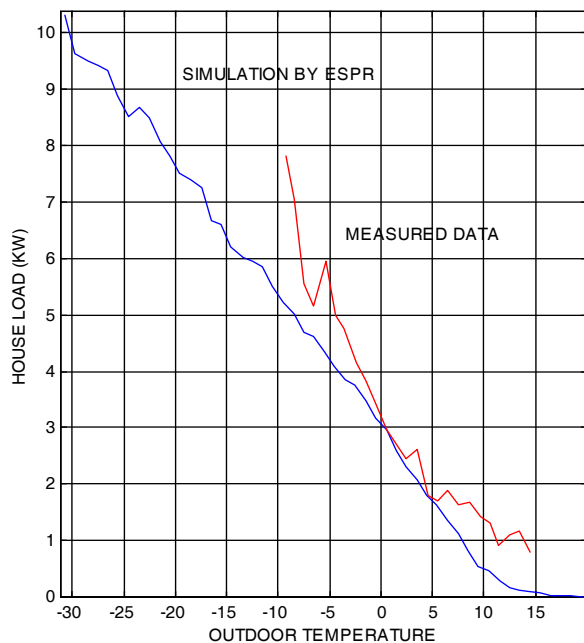

Figure 5. Simulated and measured house loads

ENERGY BALANCE ON THE STTS

As a result of the large number of data channels and transducers in the system there is a need for ongoing checks of data integrity. Data were analyzed for a twenty day period (March 27 to April 15/07) and an energy balance was performed on heat flows through the STTS. The energy flows through the STTS are shown in Figure 6. Since the STTS water storage tanks act as the central transfer point for all energy flows, this data illustrates various operating sequences of the system as well as permitting crosschecks of the monitoring system accuracy.

Since only 184 collectors were in service (23 % of the total) and there were a number of overcast days in March, solar energy collection was limited to 56.1 GJ. Energy collected in the spring period would normally be used only to supply the space heating requirements. Typically during this season, the BTES would only be charged when surplus energy was available after space heating requirements were met.

During the current commissioning phase, the BTES circulation pump is turned on for two hours every second day to avoid stagnation in the BTES U-tubes. Since the BTES is in its first season of operation and the ground is at its undisturbed temperature, circulation of STTS water through the BTES has transferred over half the energy available from the STTS into the BTES, over the 20 day period.

Over the same period, the sum of energy delivered to the BTES, energy delivered to the district loop, calculated increase in stored energy and calculated heat losses from the STTS, equals 54.0 GJ or 96.3% of the collected solar energy. The energy balance suggests that the instrumentation is working to a high degree of accuracy.

The collected solar energy is measured by three methods:

- A flowmeter dedicated to the first block of collectors
- A flowmeter on the common line to all collector blocks.

(The temperature transducers are common to both collector flow paths.)

- Independent instrumentation on the water (tank) side of the collector heat exchanger, allows an energy balance to be performed across the heat exchanger.

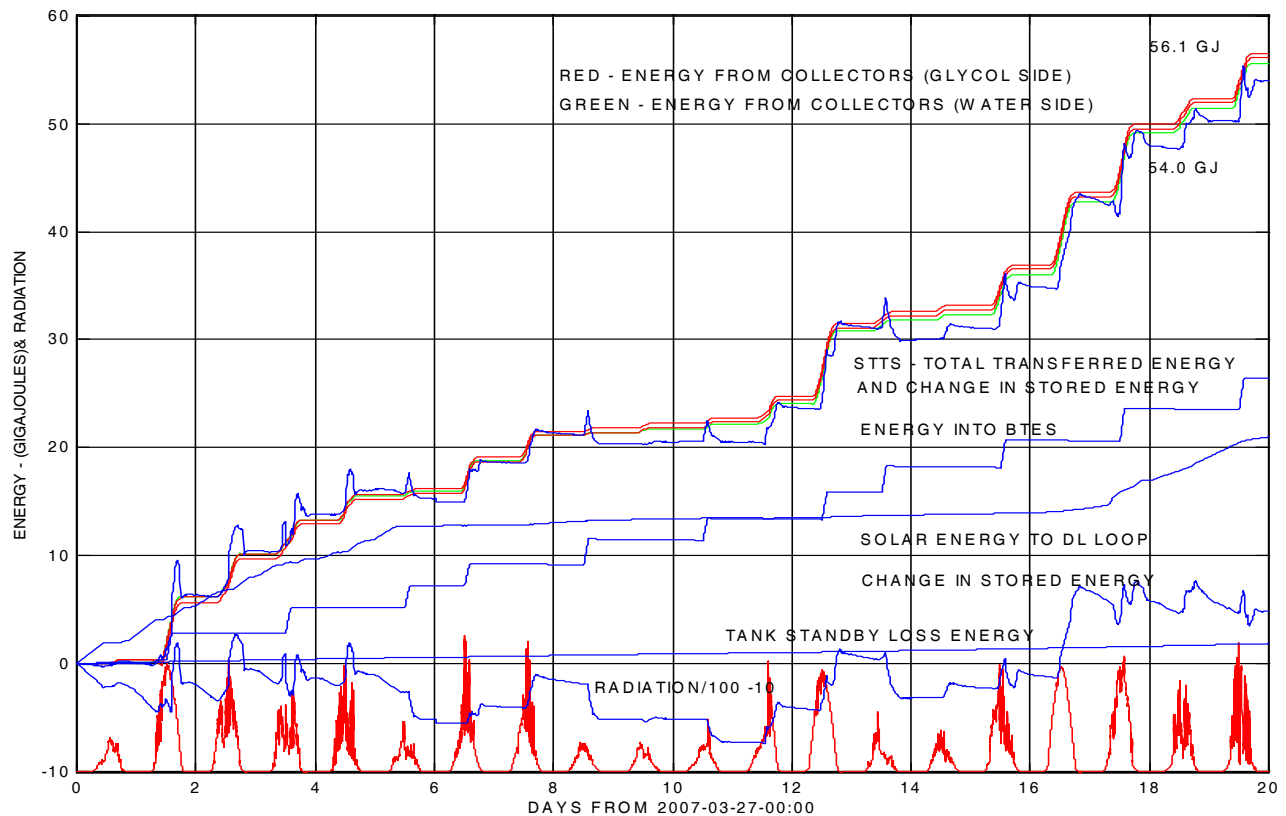

Figure 6. Energy balance on the STTS March 27 to April 15, 2007

The three methods of calculating solar energy collected agree within less than 4%.

The change in stored energy in the tanks was calculated from an estimate of the average temperature of water in different sections of the two tanks. Over the 20 day period stored energy was estimated to increase by approximately 5 GJ. This increase corresponds to the increasing availability of incident solar energy near the end of the period.

Standby losses from the tanks, based on the specified insulation thickness, were calculated to be approximately 2 GJ.

DISCUSSION

Construction and commissioning of the DLSC system is underway and nearing completion. It is expected that the second, third and fourth blocks of collectors will be filled and operating by June 2007. The monitoring system is also incomplete, however, energy balances and checks performed to-date suggest that most current temperature and flow data are reasonable. While it is too early to make definitive statements about how the system, once completed, will actually perform, the

analysis of early data is useful in confirming the performance of some components and subsystems, tuning the simulation model, assessing the operation of controls and in making preliminary predictions of as-built system performance.

The analysis presented in this paper has confirmed that the first block of 184 collectors is achieving the efficiency levels that are predicted by standard single-collector tests performed at the NSTF within about 5%. Comparisons of measured integrated collected energy with that predicted by TRNSYS, for the same weather, have not yet been made.

Comparison of monitored energy delivered to the houses with that predicted using ESP-r simulations, indicates that while the actual loads are close to predictions, in the early operation experienced to-date, they are slightly higher than predicted. There are several possible reasons for this including the short-circuit bypasses for unfinished houses, air handlers being turned-on before occupancy and higher than design district loop temperatures (raised to ensure occupant comfort in houses near the end of incomplete circuits). Next winter, when all of the houses are occupied and the system is operating normally, it is

expected that representative heat loss characteristics will be obtained.

Modelling of the system has included the use of ESP-r to establish house heating loads, a Swedish ground storage model, a district heating design model, a computational fluid dynamics package to model the STTS as well as TRNSYS and SIMULINK to model the entire system. For the current discussion, ESP-r house heating loads have been fed to a detailed TRNSYS model of the collection, storage, distribution and control systems, which has been updated to reflect a lower than design water flowrate through the BTES (observed) and recent NSTF measurements of single collector performance.

Large seasonal storage systems require a significant length of time to charge since the storage medium must be heated-up to the minimum useful temperature before any heat can be extracted. TRNSYS system simulations, which are routinely performed for 10 typical meteorological years (TMY) in a row, show that the solar fraction will be low initially but it will reach 90% by the fifth year of operation. The simulated energy flows for year five are illustrated in Figure 7.

These results represent the current best estimates of predicted system performance. Of 13,938 GJ incident on the 4 collector arrays, 4084 GJ are collected and 3,753 GJ are delivered to the STTS. Of that quantity,

2063 GJ are delivered to the BTES and 813 GJ are recovered from the BTES. The district loop is supplied with 2340 GJ of solar energy and 237 GJ from the boilers of which 249 GJ are lost from the loop and 2328 GJ are delivered to the houses. Pump energy consumption for the year totals 60 GJ.

As the DLSC system monitoring continues, the simulation model will be tuned to match measured performance, thereby improving the accuracy of prediction. It is expected that a variety of simulation based investigations will follow, including assessment of alternate control strategies and the impact of system scale and location changes.

CONCLUSIONS

Monitoring data from preliminary operation of the DLSC heating system have been analyzed. All major subsystems are operational. Solar energy is being collected, stored in the STTS, delivered to the houses on the district heating loop and delivered to the BTES.

Operating efficiency for the first block of collectors appears to be slightly above expected, based on standard collector testing at the NSTF. The peak thermal power output observed is approximately 300 kW which corresponds to 1.3 MW for the whole 798 collector array.

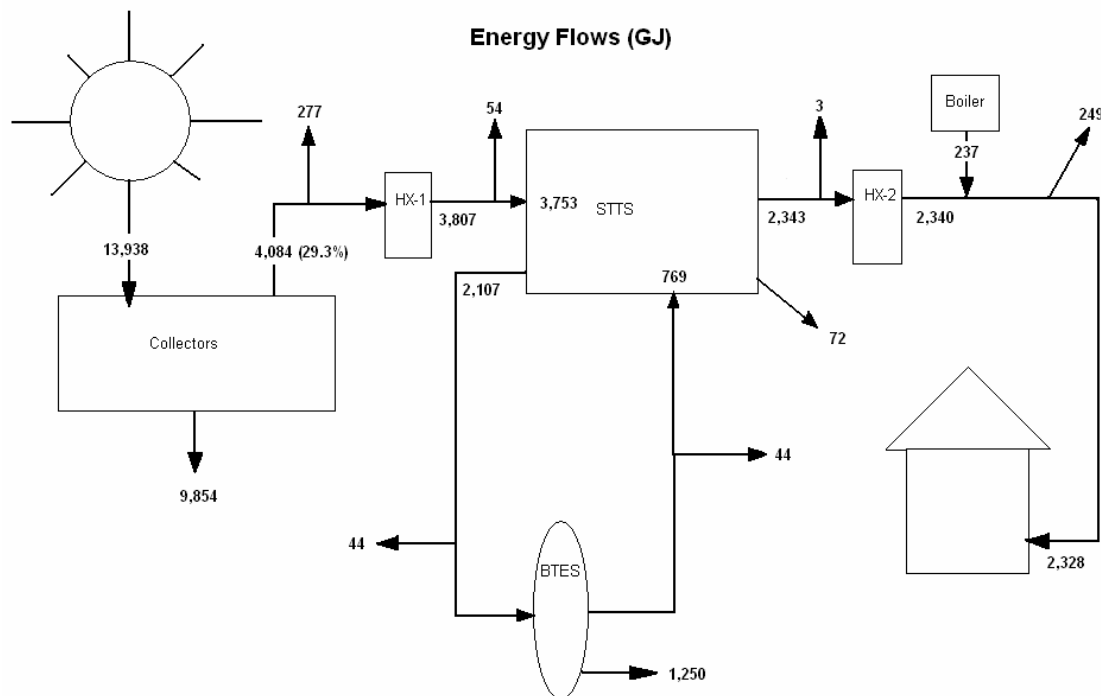

Figure 7. Energy flows in year five

Measurement of thermal power consumed by the houses during early operation is slightly higher than predicted for normal operation as may be expected due to atypical district loop operation, including, only 40 instead of 52 houses connected, house bypass plumbing and a higher than normal supply temperature schedule.

An energy balance performed for a period of 20 days on the STTS confirms good accuracy and correct operation of critical installed instrumentation.

Current best predictions of system performance indicate that a solar fraction of 90% will be achieved in year 5 of complete system operation.

ACKNOWLEDGMENTS

The authors would like to acknowledge the assistance of colleagues and associates who have contributed their expertise and ideas to the analysis. We would also like to acknowledge all of the project partners for their part in making the the Drake Landing Solar Community project a reality. A special note of thanks is due to Dr. Peter Onno for his efforts in data retrieval, transmission and software development. We also acknowledge the funding contributions of the CANMET Energy Technology Centre-Ottawa, the TEAM program, the Green Municipal Fund, the REDI program, the Program of Energy Research and Development, Sustainable Development Technologies Canada, Government of Alberta, Climate Change Central, ATCO Gas, United Communities and Sterling Homes for making the project possible.

NOMENCLATURE

G	incident solar flux (W/m^2)
$\eta_{collector}$	collector efficiency
Ta	ambient temperature (C)
Ti	inlet temperature (C)

REFERENCES

- McClenahan, D., Gusdorf, J., Kokko, J., Thornton, J., Wong, B. 2006. Okotoks: Seasonal Storage of Solar Energy for Space Heat in a New Community, ACEEE, 2006 Summer Study on Energy Efficiency in Buildings, Pacific Grove, CA USA.
- Wong, W.P., McClung, J.L., Snijders, A.L., Kokko, J.P., McClenahan, D., Thornton, J., First Large-Scale Solar Seasonal Borehole Thermal Energy Storage in Canada, Ecostock 2006 Conference, Stockton, NJ USA.

